

PVC PRESSURE SYSTEM

PVC-M

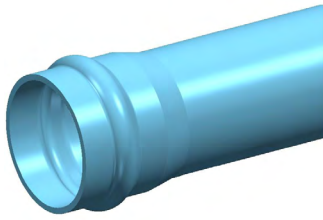

PDHR18250

DN250 x 6m PN18 Blue Rhino Series 2 PVC-M Pipe Rieber RRJ

APPLICATION Used for above or below ground applications to convey potable water in pressure applications.

FEATURES

- Australian Made
- BEP PVC - Manufactured from Best Environmental Practice PVC
- Installation Economics
- Operation Efficiencies
- Corrosion Resistant
- Light weight
- Electrically non conductive

TECHNICAL DATA

PRODUCT PROPERTIES

Primary Material	PVC-M
Colour	Blue
Joint Type	RRJ
Rubber Ring Material	EPDM
Allowable Operation Temperature - Degrees	50°C
Allowable Operating Pressure - 20°C	1800kPa
Average # of Joints per Litre – Iplex Lubricant	12
Unprotected UV Exposure (years)	2 Years
Maximum Diametric Deflection - 50 Years	7.50%
Minimum Radius of Curvature	75m
Socket Deflection	1°

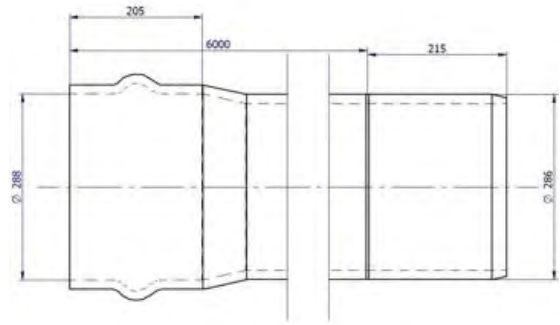

PRODUCT DIMENSIONS

Category	Length	Max Socket Nominal OD	286.2mm
Rating	PN18	Chamfer Detail	25mm
Length	6m	Witness Mark	220mm
Nominal	250mm	Weight	112kg
ID	256.6mm	Crate Qty	8
Wall Thickness	14.8mm	Crate Weight	896kg
Socket Depth	205.3mm		

ENVIRONMENTAL CREDENTIALS AND STANDARDS

Environmental Accreditation	Best Environmental PVC - PVC Certificate No. BEP-PVC 0037
Product Standard	AS/NZS 4765 "Modified PVC (PVC-M) Pipes for Pressure Applications"
Standards Mark Certification SMK02730.4, SMK02468.4, SMK02748	WSAA Appraisal - PA1612

MATERIAL PROPERTIES

MECHANICAL

Density Specific Gravity	1.47
Ultimate Tensile Strength	38MPa
Yield Strain	5.5%
Compressive Strength	48MPa
Tensile Modulus	3000MPa
Hardness Shore D	85
Poissons Ratio	0.38
Design Stress	17.5MPa
Ring Bending Modulus (3mins)	3000MPa
Ring Bending Modulus (50Yrs)	1200MPa

THERMAL

Coefficient of Thermal Expansion	$7 \times 10^{-5} / ^\circ\text{C}$
Thermal Conductivity	0.138W/m.K
Specific Heat	1047 J/kg/°C
Vicat Softening Temperature	>79°C
Flammability	Will not support combustion
Fire Index – Ignitability	2
Fire Index – Smoke Development	8
Fire Index – Spread of Flame	0
Fire Index – Heat Evolved	2

©Copyright: Iplex Pty Ltd 2019 all rights reserved. All drawings and information contained thereon are the exclusive property of Iplex Pipelines. Unless specifically noted, this drawing and information enclosed are subject to change at any time. Measures are for reference purpose only. If critical please contact Iplex Pipelines.

