

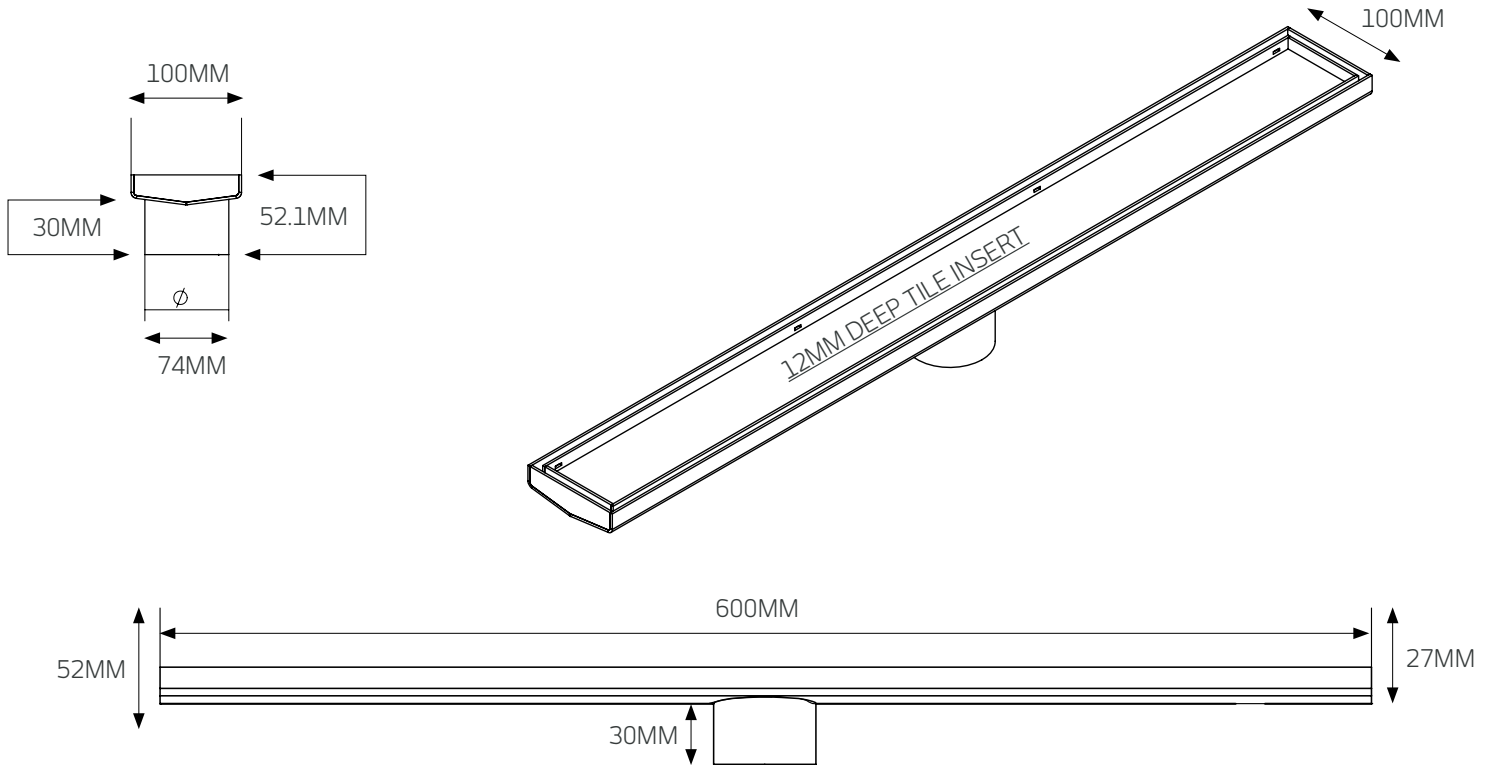

SHOWER GRATES *specifications*

RGL-600 – 600 x 100 x 74mm



FEATURES	CODE	SIZE (MM)	COLOURS	FINISH
<ul style="list-style-type: none"> • 304 stainless steel • Thickness of stainless steel is 2.3mm • Australian Watermark approved • 12mm deep insert can accommodate up to 10mm tile + adhesive • Covered by a 7 year warranty * 	RGL-600	600x100x74	Mirror Polished	Polished edges 

* The replacement warranty for the coated grates are only applicable until the date of installation. Once Installed any damage to the coatings due to the incorrect use of cleaning products, mis-use or accidental damage, will not be covered under warranty.