

Sarah

SEMI-INSET BASIN-TOP 900MM

Features

- 20mm thick, engineered quartz stone
- Gloss white ceramic semi-inset basin, no overflow
- Stone top and basin are delivered in separate packages
- Requires 32mm waste, with overflow (not included)
- 12 o'clock tap hole as standard
 - For 3 tap holes add \$50 per bowl to the price and '-3' to the end of the code e.g. PC90-3
 - For no tap holes add \$140 per bowl to the price and '-0' to the end of the code e.g. PC90-0. (SPECIAL ORDER ONLY – allow 1-2 weeks for delivery)

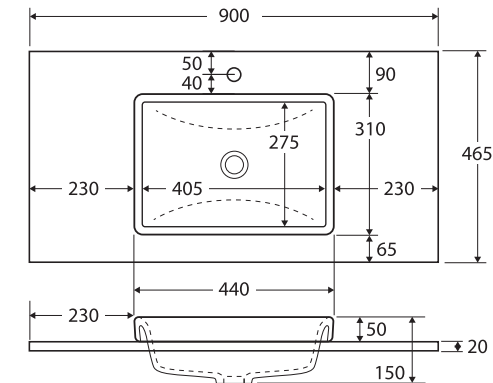

Available in



Crystal Pure
PC90



Calacatta Marble
PM90



Bianco Marble
PI90



Roman Sand
PA90



Dove Grey
PD90



Black Sparkle
PB90

Cleaning & Care

- Wipe with a clean, soft cloth and mild soapy water or non-abrasive bathroom cleaner. Test in an inconspicuous area before cleaning the whole top or basin.
- Avoid placing hot objects, such as hair straighteners, on any surface as these will cause discolouration and marking.
- Spills of hair dye, after-shave lotion, nail polish and remover, aerosol spray and other harsh chemicals should be removed immediately to prevent damage and discolouration. Clean immediately with mild soapy water using a clean, soft cloth.

While we aim to ensure specifications are correct at the time of publication, Fienza reserves the right to make modifications without prior notice. Physical colour may vary from image shown. All measurements are shown in millimetres. Always use physical product measurements for mark-ups and roughing-in as the technical drawing may differ from actual product received. Tapware not included.