

Nu-Petite

Proudly Aussie made

All dimensions in mm

NP602

1 & 1/2 Bowl Topmount Sink With Drainer

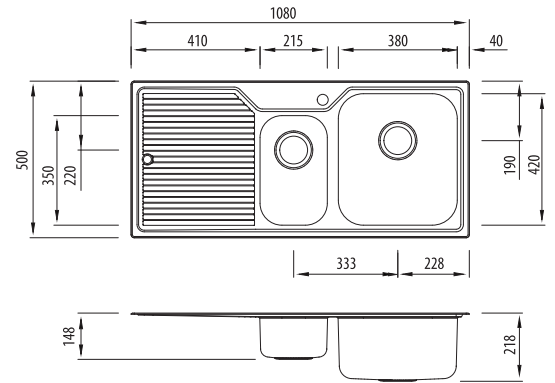

Specifications /

Sink size	1080W x 500H mm
Bowl size	Main Bowl 380W x 420H x 200D / 30L 1/2 Bowl 215W x 350H x 130D / 9L
Construction	2 piece, bowls and drainer seam welded
Material	304 grade, 18/10 polished stainless steel (0.8 mm thick)
Installation	Topmount
Fixings	Adjustable clips and sealing foam supplied
Min cabinet size	700 mm
Tap holes	Available 0 to 3 tap hole (specify when ordering)
Waste fittings	2 x 90 mm basket wastes included
Overflow	Not available
Carton size	1267 x 567 x 237 mm
Weight	8 kg
Warranty	Lifetime manufacturer's warranty (refer to oliveri.com.au)
Maintenance and care instructions	All surfaces should be cleaned with mild liquid detergent or soap and water. To maintain the shine on your Oliveri stainless steel sink, we recommended the use of any of the easy to obtain, non-abrasive stainless steel cleaners or metal polishes.

Included accessories /

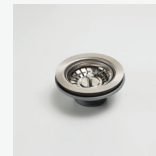

AC14
Basket Waste



AC14
Basket Waste



AC65
Bamboo Board



AC62
Colander