

Caroma®

| | | |
|--------|---------------|----|
| CI/SfB | (74.4) | g3 |
| Date | November 2015 | |

Supersedes all previous issues

Small Laboratory Sink

Nominal Size 305mm x 305mm x 225mm

7.07.1

Medium Laboratory Sink

Nominal Size: 375mm x 375mm x 265mm

Large Laboratory Sink

Nominal Size: 405mm x 480mm x 265mm



Laboratory Sinks



A range of plain outlet, straight sided Laboratory Sinks as detailed below:

Small Laboratory Sink 305mm x 305mm x 225mm nominal, centre outlet, max. capacity 10 litres
- Code No.674101.

Medium Laboratory Sink 375mm x 375mm x 265mm nominal, centre outlet, max. capacity 15 litres
- Code No.674102.

Large Laboratory Sink 405mm x 480mm x 265mm nominal, offset outlet, max. capacity 25 litres
- Code No.674103.

Tap Holes: **Laboratory Sinks** - None. The sinks are intended for installation with counter top mounted laboratory cocks etc. The Laboratory Sinks have light glazing on the external surfaces.

Waste Outlets: Plain outlet only, suitable for 50mm standard waste assemblies (not supplied). For duty involving acid and other corrosive wastes, special waste assemblies may be required (not supplied).

Fixing: For under counter applications: **Aluminium Clip Bracket** (not supplied), use for fixing basin to marble or granite counter top. Four brackets are used with each sink. For custom applications the client must provide own custom bracket system.

Colours: White only.

Dimensions: All dimensions are in millimetres and are subject to normal manufacturing variations. Caroma pursues a policy of continuing improvement in design and performance of its products. The right is therefore reserved to vary specifications without notice.



Small
Laboratory Sink

Medium
Laboratory Sink

Large
Laboratory Sink

Small and Medium Laboratory Sinks

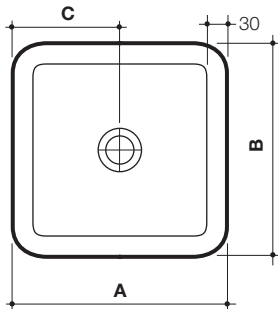

Large Laboratory Sink

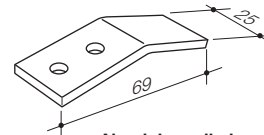
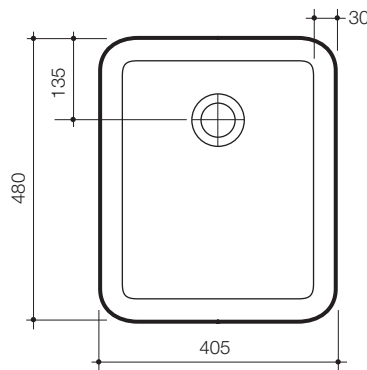

Aluminium clip bracket
Code No.813734

IMPORTANT Under counter marble top fixing

Use only an acetic cured silicone sealant. Epoxy type glues must not be used.

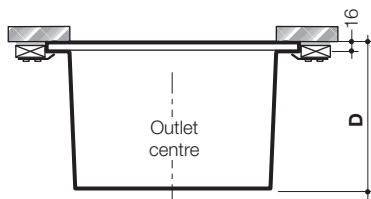
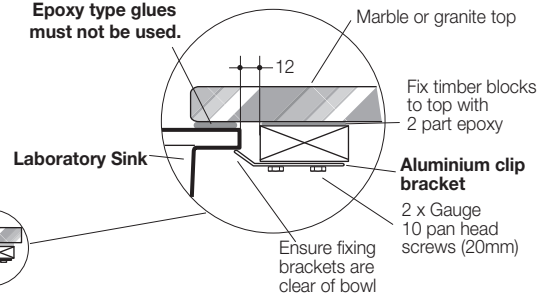

Takes 50mm diameter standard waste assembly

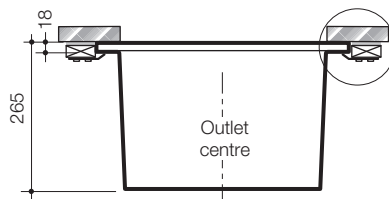

Takes 50mm diameter standard waste assembly

| | A | B | C | D |
|-------------------------------|-----|-----|-----|-----|
| Small Laboratory Sink | 305 | 305 | 152 | 225 |
| Medium Laboratory Sink | 375 | 375 | 187 | 265 |

Cut-out Size

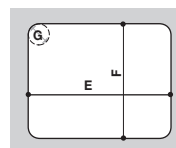

Counter top Cut-out for normal under-counter installation

| | E | F | G |
|-------------------------------|-----|-----|----|
| Small Laboratory Sink | 220 | 220 | 20 |
| Medium Laboratory Sink | 286 | 286 | 20 |
| Large Laboratory Sink | 384 | 304 | 20 |