



AVK SWING CHECK VALVE, PN16

41/80
41/81
41/82

Resilient seated swing check valve AS 4794

Flange and drilling to AS 4087 Figure B5 (AS 2129 Table D and raised face) or AS 2129 Table E and raised face

Use:

- For potable water and sewage applications
 - Valve designed for use up to 60°C
 - Where applicable; for AS 4020 compliance, max temp = 40°C
- Note: Always observe pipe material recommended operating temperatures

Tests:

- Hydrostatic test to AS 4794:
 - Seat: 16 bar
 - Body: 24 bar
 - Sensitivity: 70kPa

Options:

- Closed bushing (free acting) - series 41/80
- Free acting - series 41/81
- Lever and weight - series 41/82 (mounted RHS as standard or can be mounted LHS on request)
- Limit switch and cam
- Proximity switch and cam
- Up and down stream tapping points

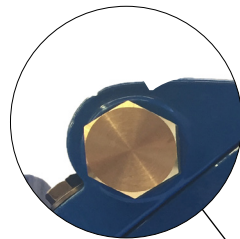

Closed Bushing

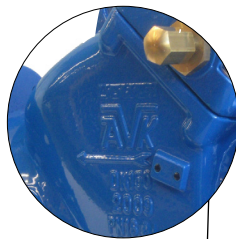

Free Acting

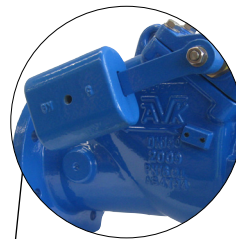

Lever & Weight

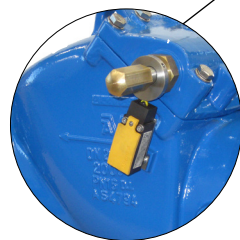

Free Acting
+
Limit Switch

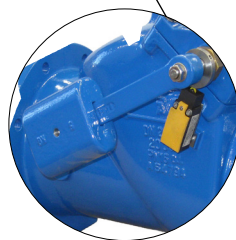

Lever & Weight
+
Limit Switch



Proximity Switch
and Cam



Quality
ISO 9001



Health & Safety
AS 4801



Environment
ISO 14001

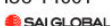

Australian
Standard
AS 4794

Lic. SMK20363
SAI Global



Lic No: WMK20363

Expect... **AVR**

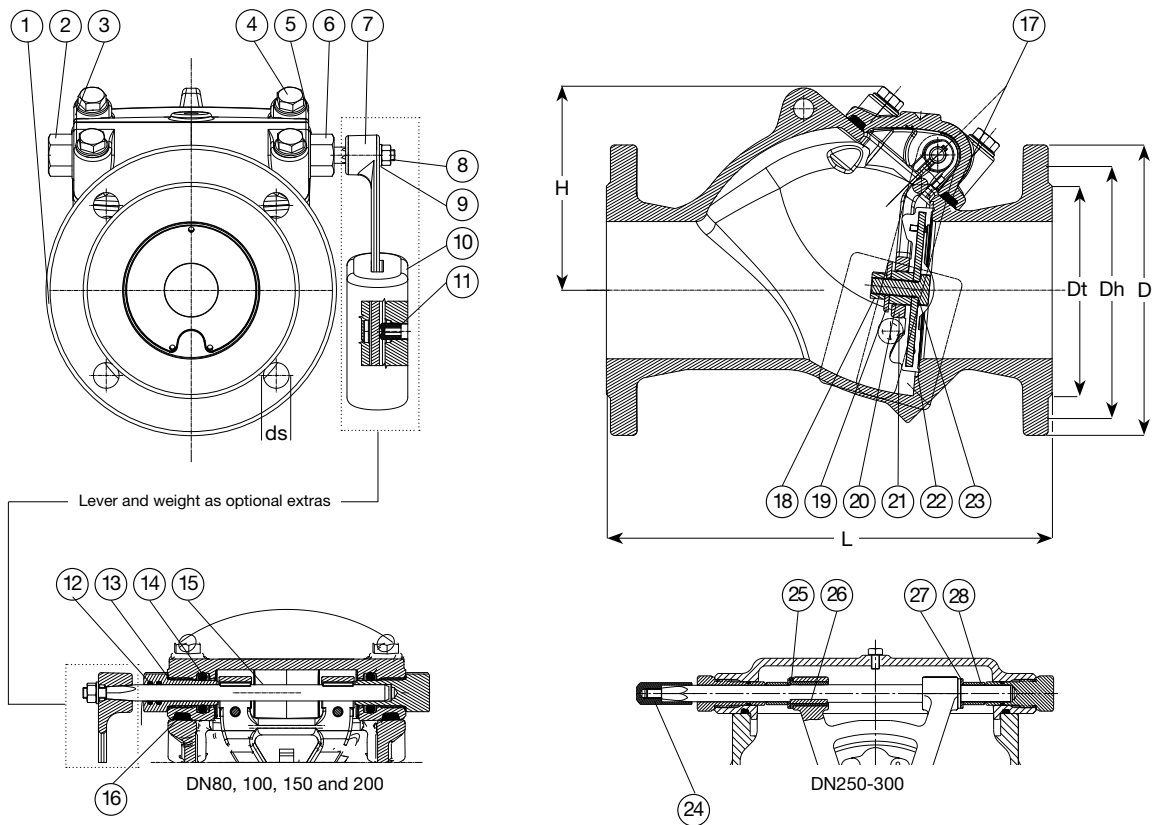

Component list

1. Body	Ductile Iron to AS 1831 grade 500-7	15. Shaft	Stainless Steel to ASTM A276 SS431
2. Bushing closed	Copper alloy AS/NZS 1567 C486	16. Bonnet gasket	EPDM rubber
3. Bonnet	Ductile Iron to AS 1831 grade 500-7	17. Tab washer	Stainless Steel 316
4. Hexagon bolt	Stainless Steel A4	18. Nut	Stainless Steel 316
5. Washer	Stainless Steel A4	19. Washer	Stainless Steel A4
6. Bushing open	Copper alloy AS/NZS 1567 C486	20. Bushing	Copper alloy AS/NZS 1567
7. Lever	Ductile Iron to AS 1831 grade 500-7	21. Hinge	Stainless Steel to ASTM A276 Gr. 316
8. Nut	Stainless Steel 316	22. Rubber disc	EPDM rubber
9. Washer	Stainless Steel A4	23. Hexagon bolt	Stainless Steel A4
10. Weight	Ductile Iron to AS 1831 grade 500-7	24. Shaft protector	
11. Grub screw	Stainless Steel 316	25. Connector	
12. O-ring	EPDM	26. Key	
13. O-ring	EPDM	27. Retaining washer	Stainless Steel 316
14. O-ring	EPDM	28. Spacer	

Components can be substituted with equivalent or higher class materials.

**Reference nos. and dimensions - Flange drilling to AS 4087 Figure B5 (AS 2129 Table D)
Closed Bushing**

AVK ref. nos.	DN	L	H	Dt	D	Dh	ds	Holes	Weight
	mm	mm	mm	mm	mm	mm	mm	nos.	kg
41-080-800271206	80	260	140	122	185	146	18	4	16
41-100-800271206	100	330	150	154	215	178	18	4	23
41-150-800271206	150	410	195	209	280	235	18	8	49
41-200-800271206	200	540	230	264	335	292	18	8	80
41-250-800271206	250	640	270	328	405	356	22	8	200
41-300-800271206	300	700	300	376	455	406	22	12	249

Reference nos. and dimensions - Flange drilling to AS 2129 Table E - Closed Bushing

AVK ref. nos.	DN	L	H	Dt	D	Dh	ds	Holes	Weight
	mm	mm	mm	mm	mm	mm	mm	nos.	kg
41-080-800271206	80	260	140	122	185	146	18	4	16
41-100-800371206	100	330	150	154	215	178	18	8	23
41-150-800371206	150	410	195	209	280	235	22	8	49
41-200-800371206	200	540	230	264	335	292	22	8	80
41-250-800371206	250	640	270	328	405	356	22	12	200
41-300-800371206	300	700	300	376	455	406	26	12	249

Reference nos. and dimensions - Flange drilling to AS 4087 Figure B5 (AS 2129 Table D) Free Acting

AVK ref. nos.	DN	L	H	Dt	D	Dh	ds	Holes	Weight
	mm	mm	mm	mm	mm	mm	mm	nos.	kg
41-080-81027120X	80	260	140	122	185	146	18	4	16
41-100-81027120X	100	330	150	154	215	178	18	4	23
41-150-81027120X	150	410	195	209	280	235	18	8	49
41-200-81027120X	200	540	230	264	335	292	18	8	80
41-250-81027120X	250	640	270	328	405	356	22	8	200
41-300-81027120X	300	700	300	376	455	406	22	12	249

X: 6 = No Switch 7 = With Limit Switch & CAM 8 = With Proximity Switch & Cam

Reference nos. and dimensions - Flange drilling to AS 2129 Table E - Free Acting

AVK ref. nos.	DN	L	H	Dt	D	Dh	ds	Holes	Weight
	mm	mm	mm	mm	mm	mm	mm	nos.	kg
41-080-81027120X	80	260	140	122	185	146	18	4	16
41-100-81037120X	100	330	150	154	215	178	18	8	23
41-150-81037120X	150	410	195	209	280	235	22	8	49
41-200-81037120X	200	540	230	264	335	292	22	8	80
41-250-81037120X	250	640	270	328	405	356	22	12	200
41-300-81037120X	300	700	300	376	455	406	26	12	249

X: 6 = No Switch 7 = With Limit Switch & CAM 8 = With Proximity Switch & Cam

Reference nos. and dimensions - Flange drilling to AS 4087 Figure B5 (AS 2129 Table D) Lever & Weight

AVK ref. nos.	DN	L	H	Dt	D	Dh	ds	Holes	Weight
	mm	mm	mm	mm	mm	mm	mm	nos.	kg
41-080-82027120X	80	260	140	122	185	146	18	4	19
41-100-82027120X	100	330	150	154	215	178	18	4	25
41-150-82027120X	150	410	195	209	280	235	18	8	54
41-200-82027120X	200	540	230	264	335	292	18	8	85
41-250-82027120X	250	640	270	328	405	356	22	8	207
41-300-82027120X	300	700	300	376	455	406	22	12	256

X: 6 = No Switch 7 = With Limit Switch & CAM 8 = With Proximity Switch & Cam

Reference nos. and dimensions - Flange drilling to AS 2129 Table E - Lever & Weight

AVK ref. nos.	DN	L	H	Dt	D	Dh	ds	Holes	Weight
	mm	mm	mm	mm	mm	mm	mm	nos.	kg
41-080-82027120X	80	260	140	122	185	146	18	4	19
41-100-82037120X	100	330	150	154	215	178	18	8	25
41-150-82037120X	150	410	195	209	280	235	22	8	54
41-200-82037120X	200	540	230	264	335	292	22	8	85
41-250-82037120X	250	640	270	328	405	356	22	12	207
41-300-82037120X	300	700	300	376	455	406	26	12	256

X: 6 = No Switch 7 = With Limit Switch & CAM 8 = With Proximity Switch & Cam